

### Technical drawing

**5 x**  Easy set up: 45 minutes

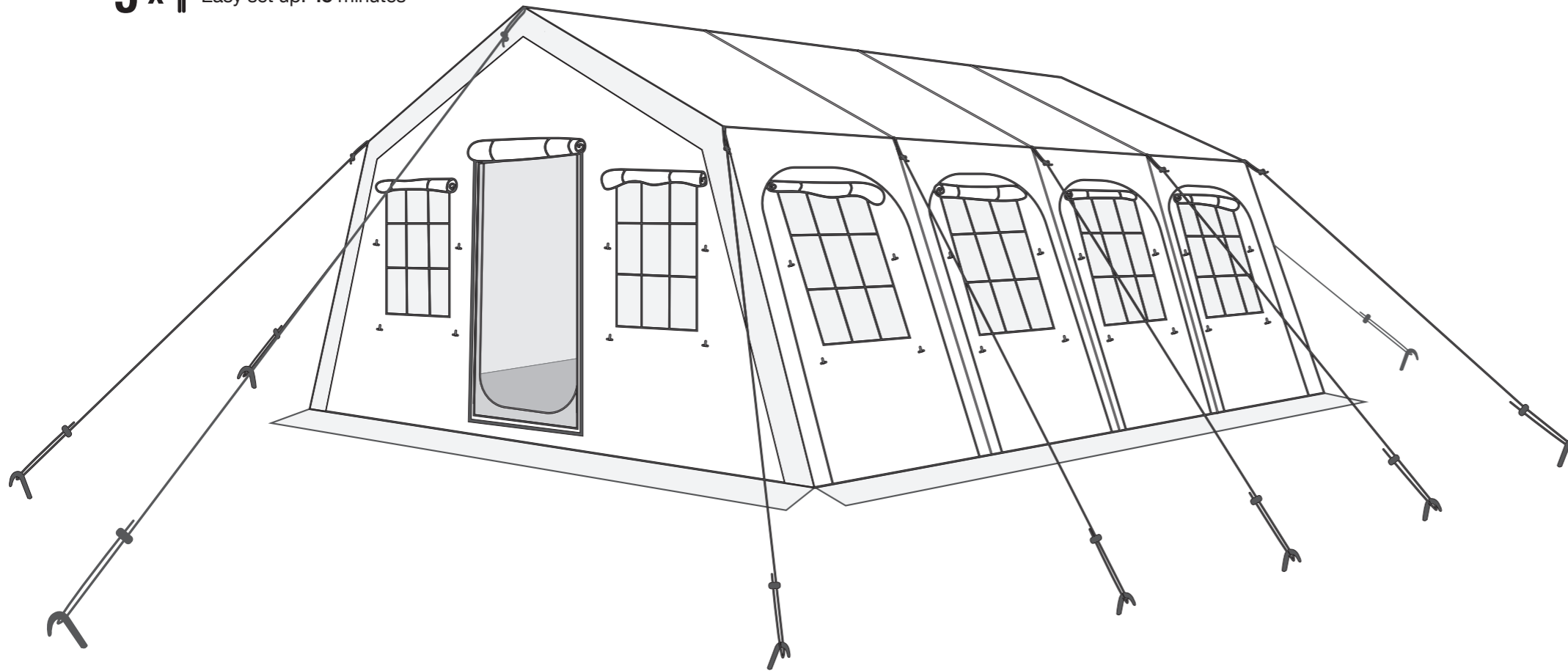

General view

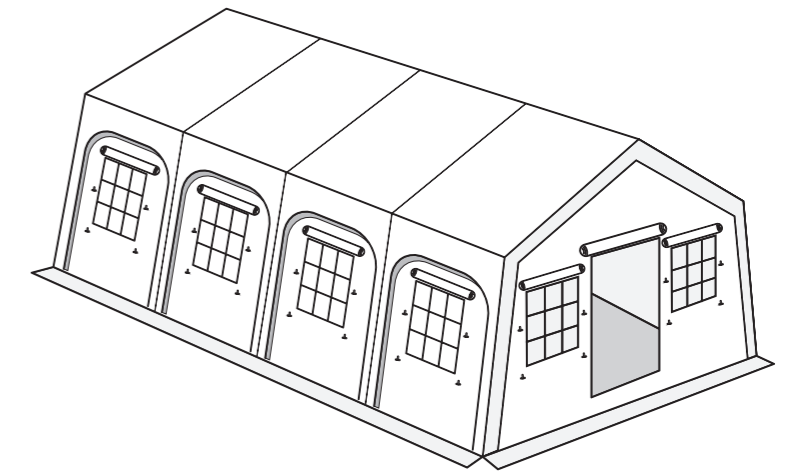



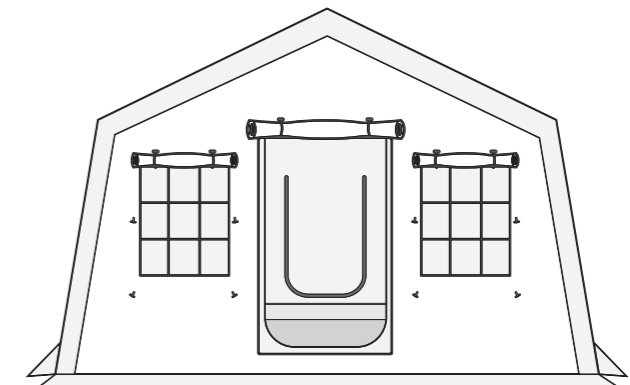



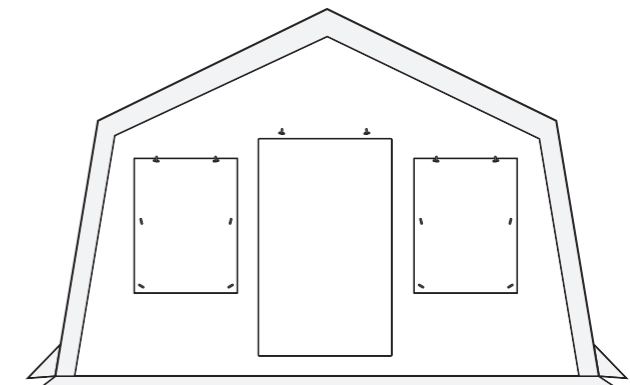













Front view



Rear view



### Packing list

1	<b>24x</b> Tent poles		12	<b>5x</b> Hooks	
2	<b>2x</b> Central gable end base poles		13	<b>20x</b> Tent poles	
3	<b>4x</b> Base plate joints (gable end centre)			<b>1x</b> Roof	
4	<b>2x</b> Base plate joints (gable end right corner)			<b>2x</b> Wall panel	
5	<b>2x</b> Base plate joints (gable end left corner)			<b>2x</b> Door panel	
6	<b>6x</b> Base plate joints (side)			<b>1x</b> Inner tent	
7	<b>2x</b> Upper frame joints (corner to corner)			<b>12x</b> Pegs	
8	<b>3x</b> Upper frame joints (side to side)			<b>1x</b> Hammer	
10	<b>2x</b> Upper frame joints (gable end apex)			<b>1x</b> Repair kit	
11	<b>3x</b> Upper frame joints (central)			<b>1x</b> Assembly manual	

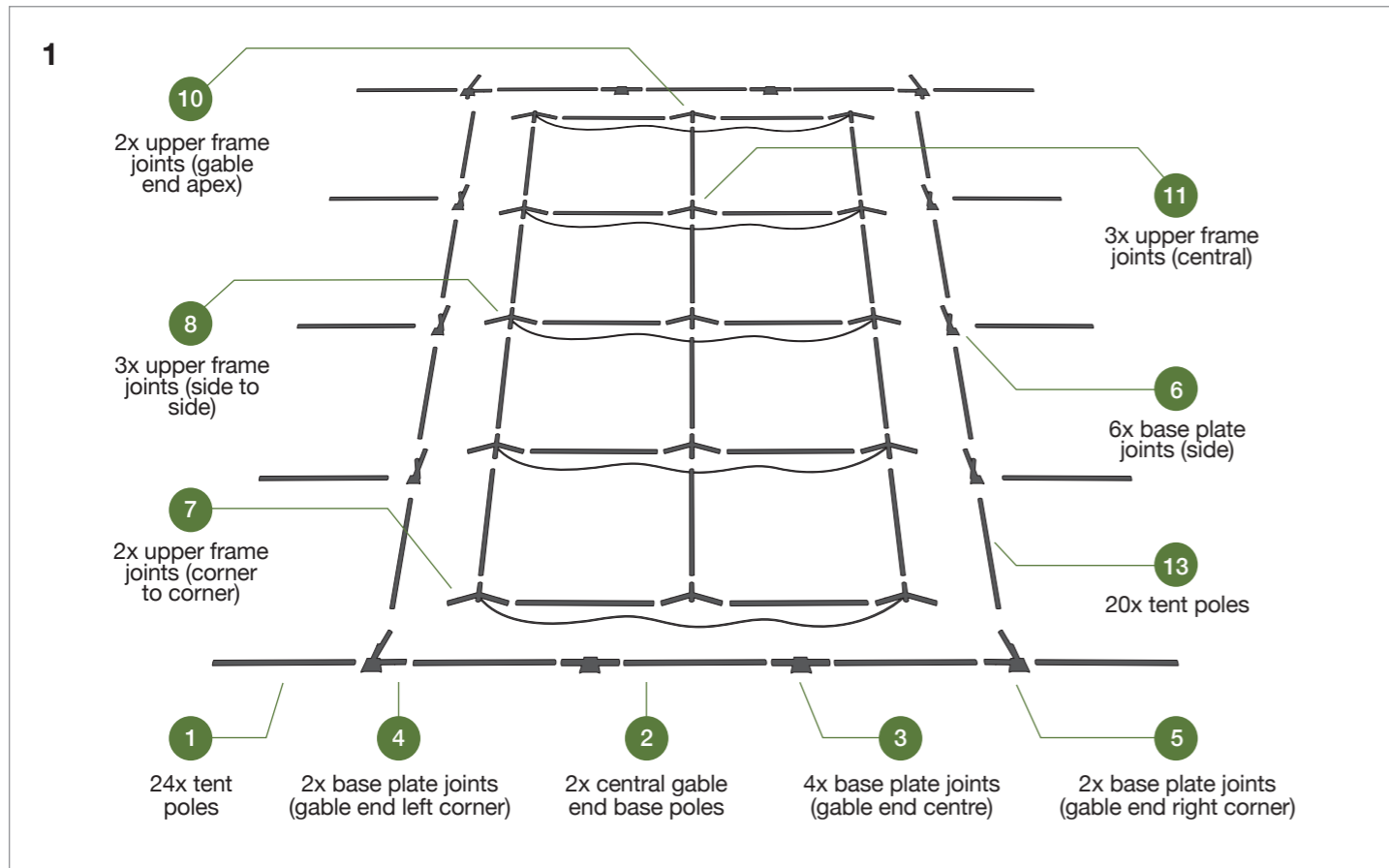

Layout all the poles and joints.

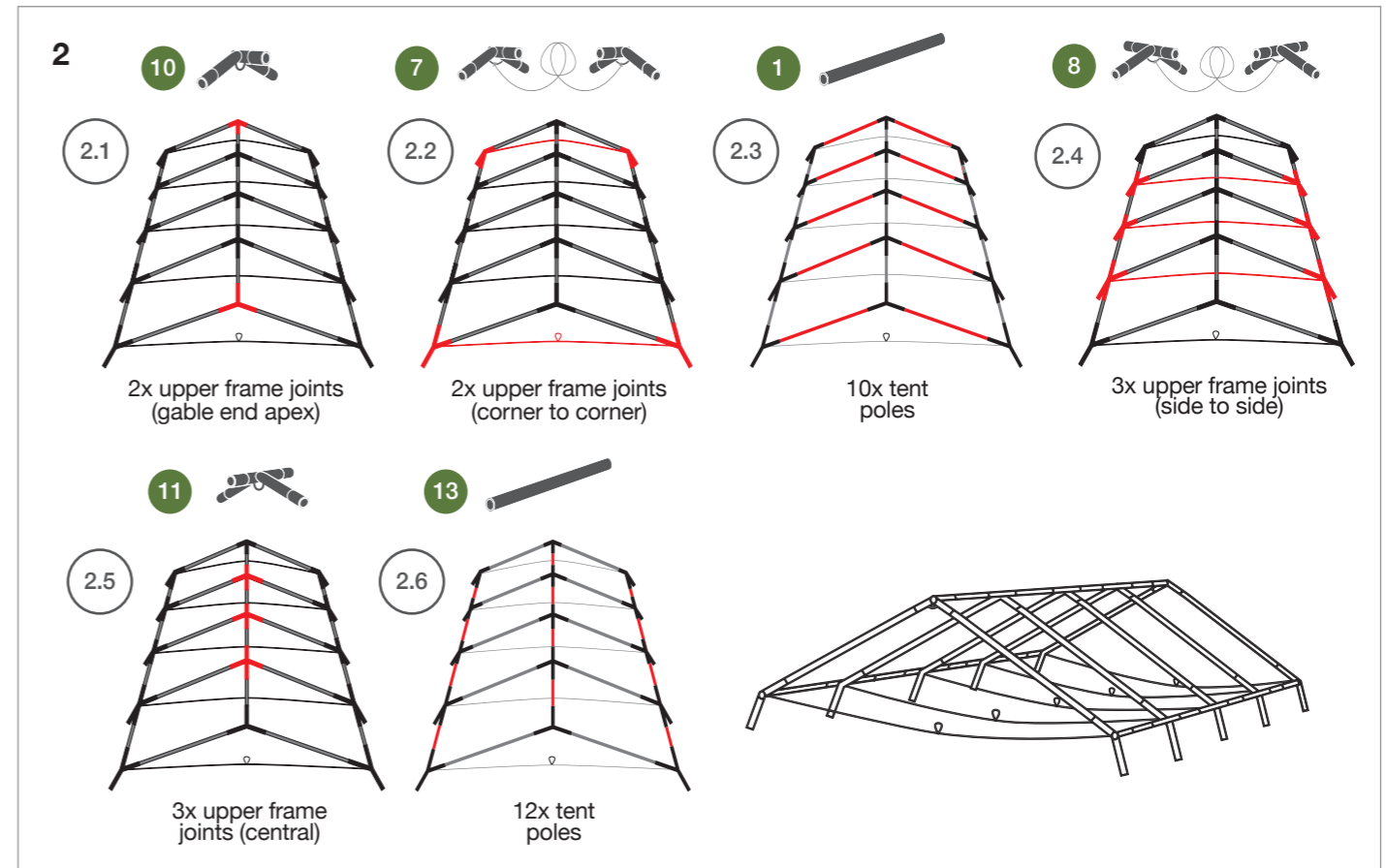

Assemble the upper frame by connecting tent poles to all the apex joints.

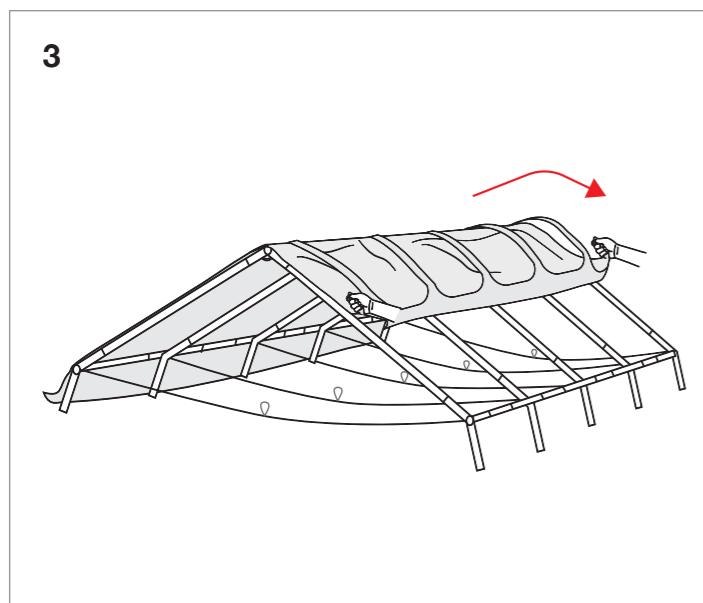

Partially spread the outer tent over the upper frame so that it covers the ridge pole.

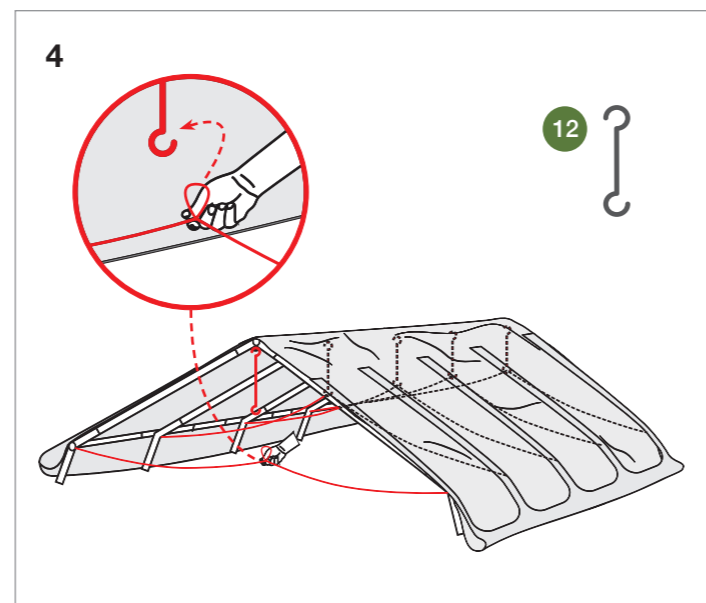

Connect the plastic cables to the upper frame apex joints with the hooks.

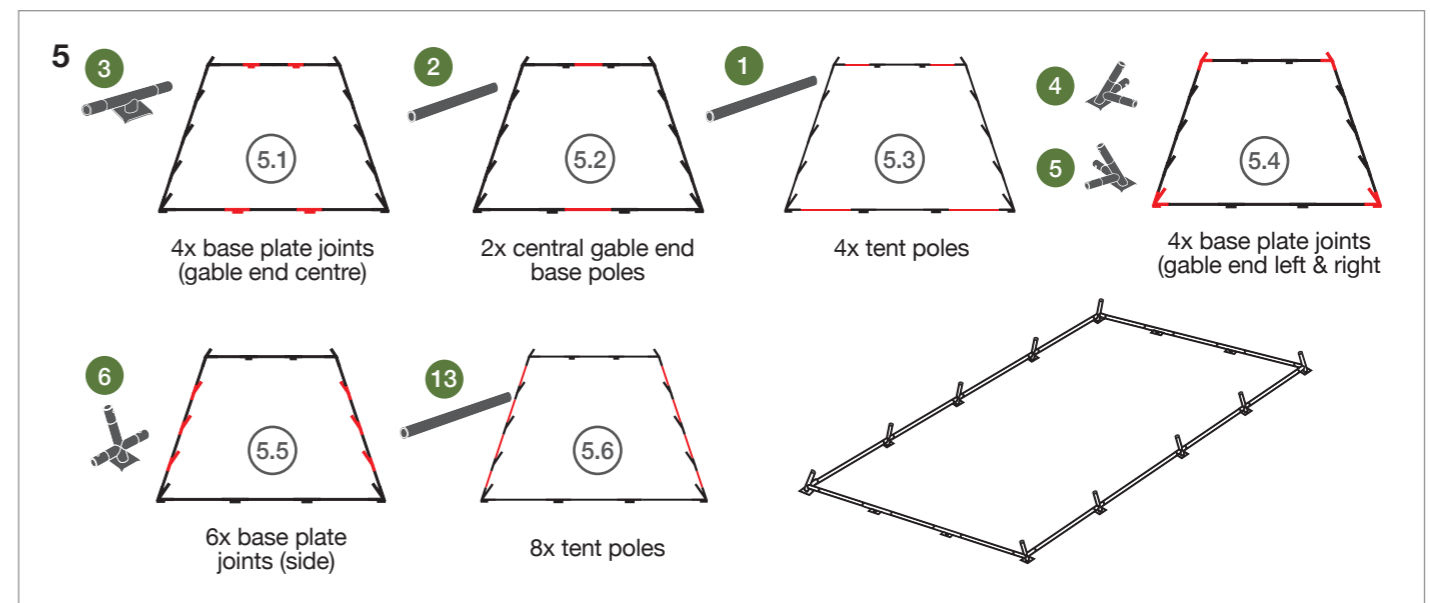

Assemble the lower frame by connecting all base plate joints with tent poles.

6

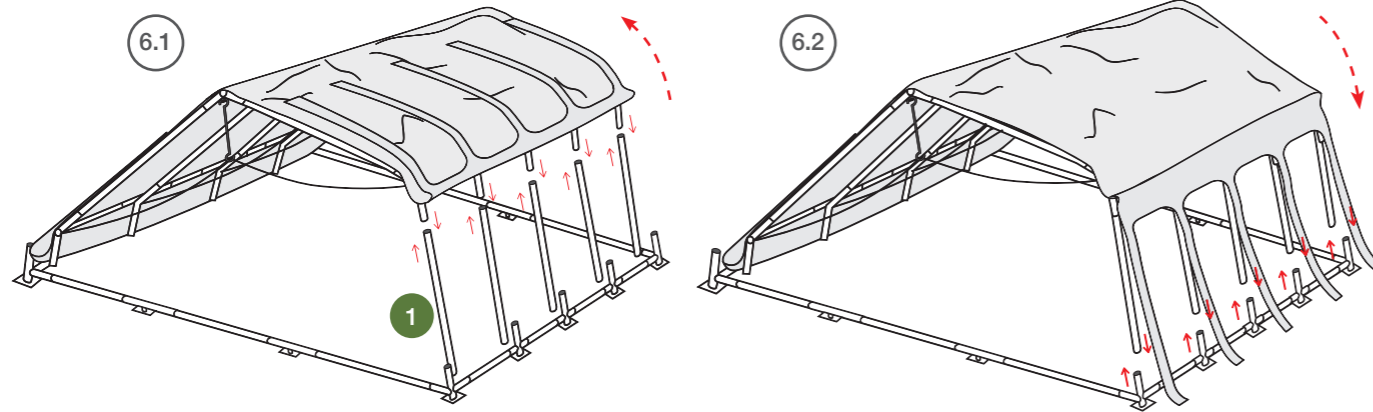

Lift the upper frame. Use the tent poles to connect the upper frame joints with the lower side joints. Repeat for the other side.

7

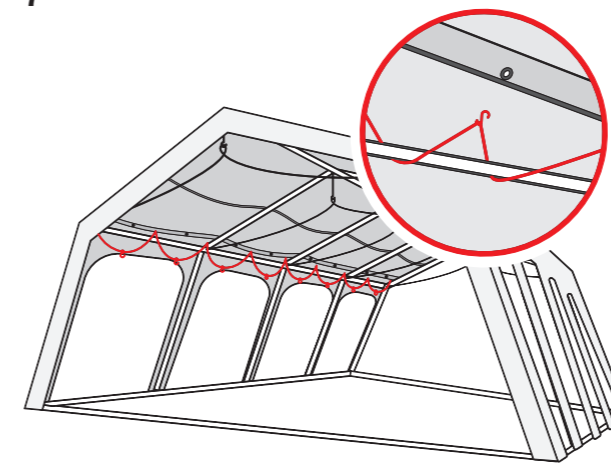

Secure the roof by looping the black ropes around the upper frame tent poles and hook to the roof eyelets.

8

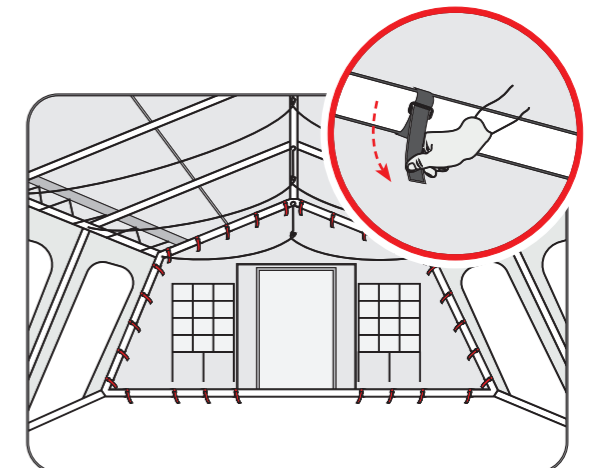

Attach door panels to the upper frame, lower frames and corner poles using buckles.

9

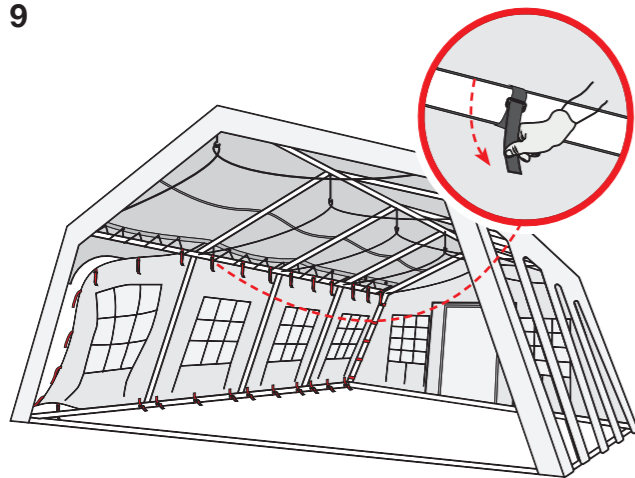

Attach side panels to the upper frame, lower frame and corner poles using buckles. Ensure windows are aligned between poles.

10

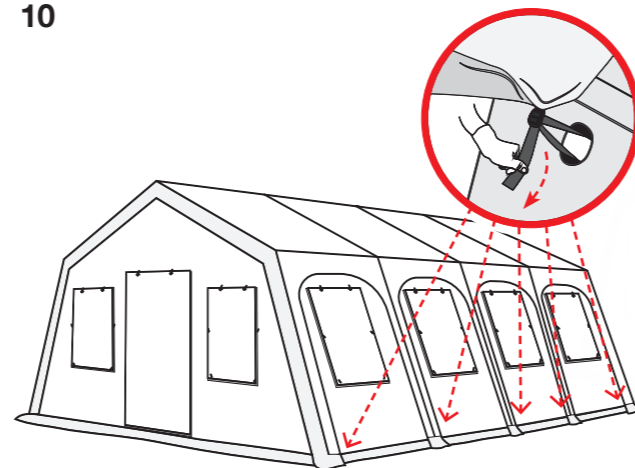

From the outside, attach the side panels and secure the tent to the lower frame using the buckles from all sides.

11

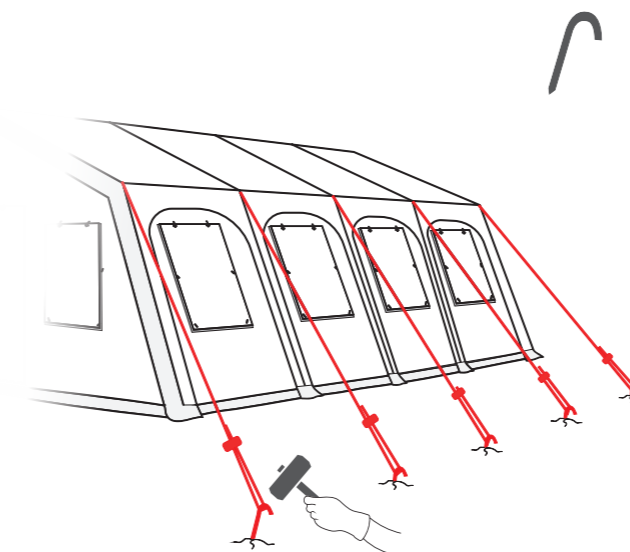

Pull out all guy ropes and secure to the ground using steel pins. Tighten with sliders.

12

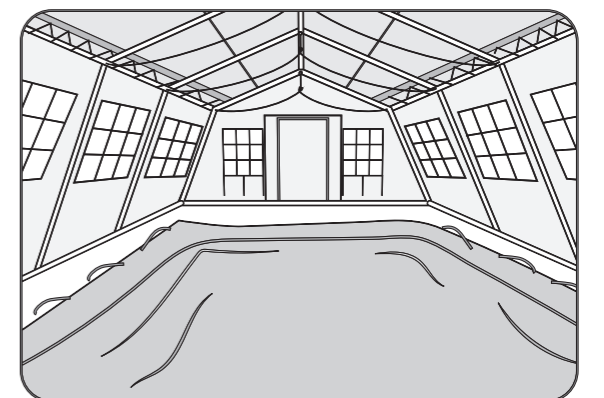

Lay out the inner tent.

13

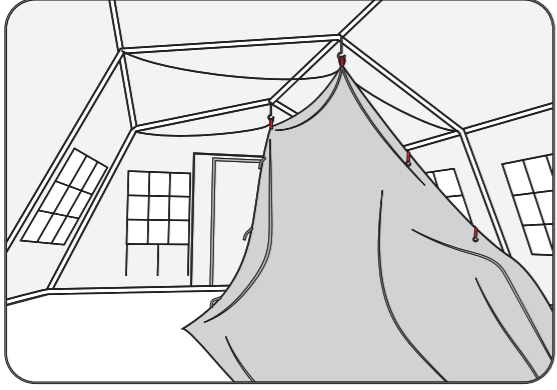

Insert the inner tent apex hooks through the hanging loops.

14

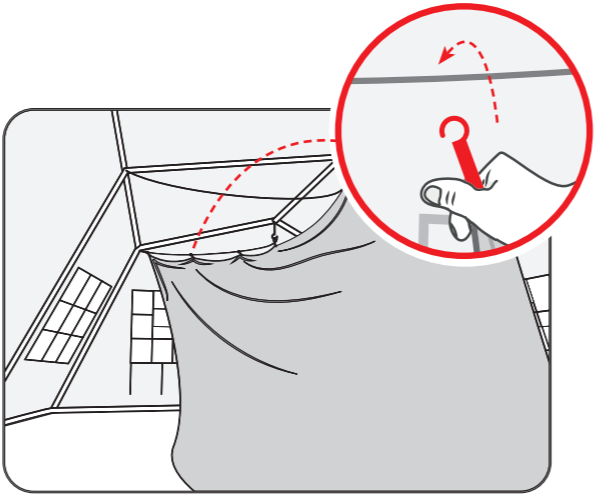

Secure the rest of the inner tent by hooking it onto the plastic cables.

15

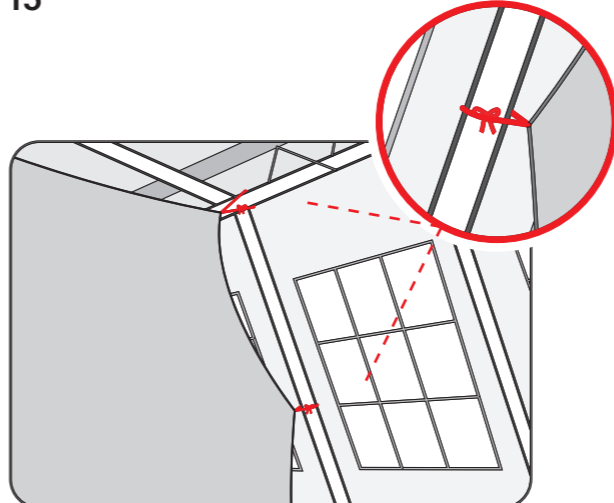

Tie the inner tent to the upper side poles and standing poles using the ribbons.

16

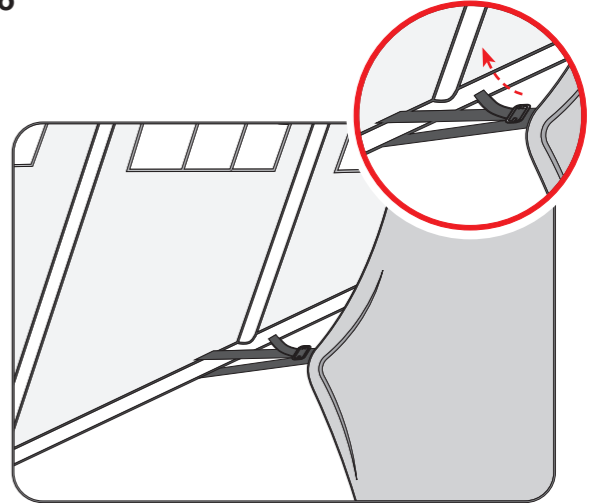

Secure the inner tent to the lower frame with the buckles.

**General Usage Notes**



Roll up all inner windows flaps and secure using the toggles.

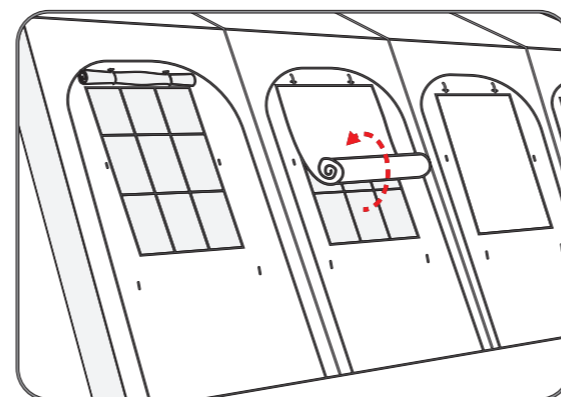

Roll up the window flaps and secure using the toggles.

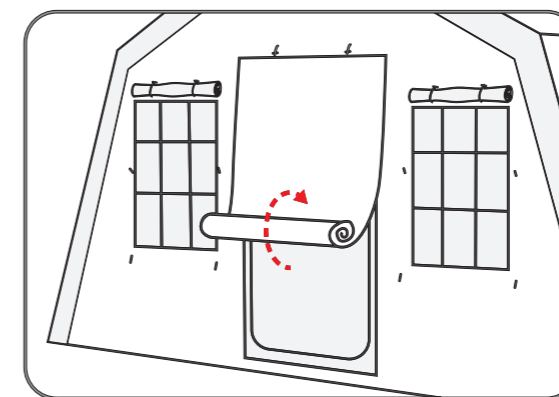

Roll up the front door flap and secure using the toggles.