

Tent Assembly Manual
Core Relief Items

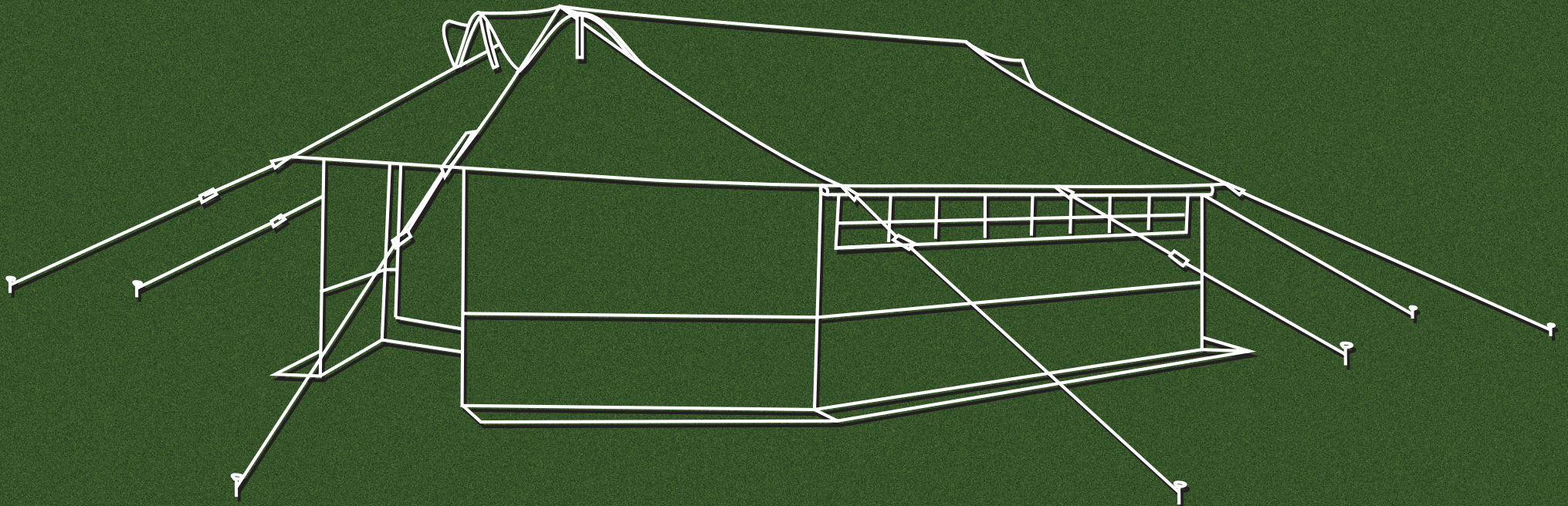

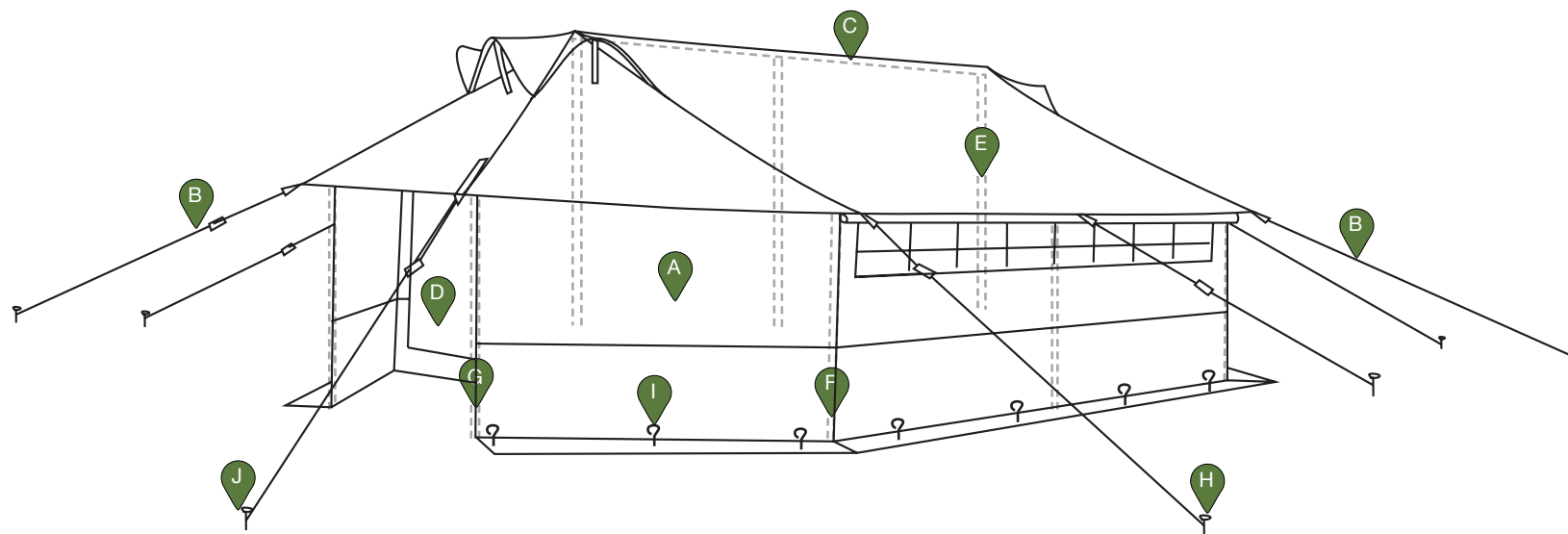





Viva™ Family Tent

DFID/Save the Children Standard

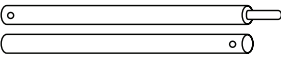

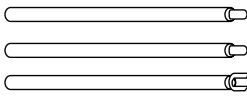
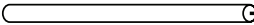
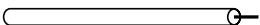
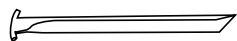

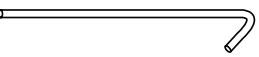
Components

| | | | | | |
|---|--|---|--|---|--|
| <p>(A)</p>  <p>1 x outer tent</p> | <p>(B)</p>  <p>12 x pre-installed guy ropes</p> | <p>(C)</p>  <p>2 x 4m ridge pole sections</p> | <p>(D)</p>  <p>1 x inner tent</p> | <p>(E)</p>  <p>3 x 2.2m standing poles</p> | <p>(F)</p>  <p>6 x 1.25m side poles</p> |
| <p>(G)</p>  <p>4 x 1.4m door poles</p> | <p>(H)</p>  <p>12 x V-shaped pegs</p> | <p>(I)</p>  <p>26 x steel pins</p> | <p>(J)</p>  <p>12 x J-shaped pegs</p> | <p>(K)</p>  <p>1 x hammer</p> | <p>(L)</p>  <p>1 x inner partition</p> |



Viva Family Tent

1

Unpack and unroll the tent

Place the contents next to the erection site.

4 m

2 x ridge pole sections

2

Connect the ridge pole parts (C) together.

2.2 m

2 x standing poles (E)

3

Slot two standing poles into the hole at each end of the ridge pole.

1.25 m

6 x side poles (F)

4

Place the side poles on the ground parallel to the standing poles.



5

1.4 m

4 x door poles (G)

Place two door poles on the ground to each side of the standing poles.

6

1 x Outer tent (A)

Fold out the outer tent on the ground next to the poles.

7

Fold the outer tent open, exposing the Velcro loops on the centre line. The inside of the tent should now be facing up.

8

Flip the outer tent upside down. The outside of the tent is now facing up.



9

Fold the outer tent in half over the centre line so that the Velcro loops are exposed.

10

Place the outer tent on top of the poles so that the centre line and Velcro loops are aligned with the ridge pole.

11

Attach the outer tent to the ridge pole with the Velcro loops.

12

Fold the top half of the outer tent back over the poles, outside facing up.

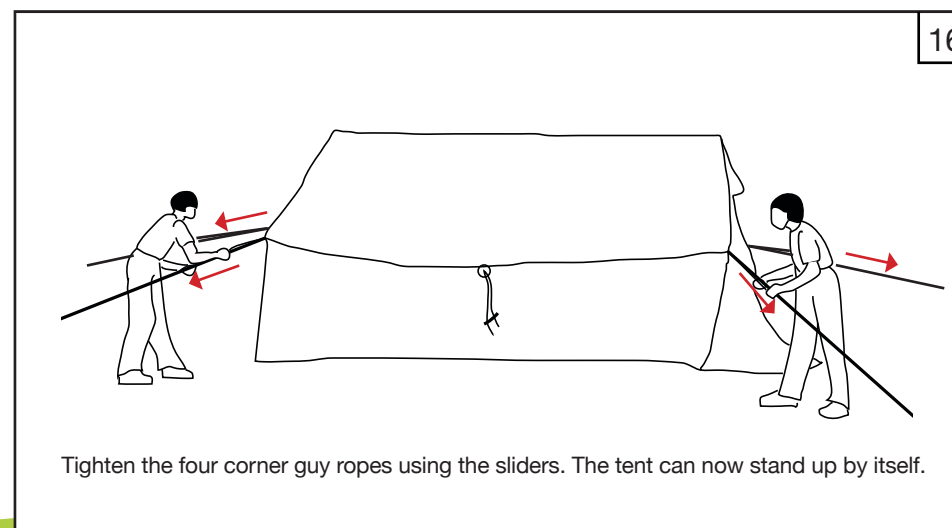
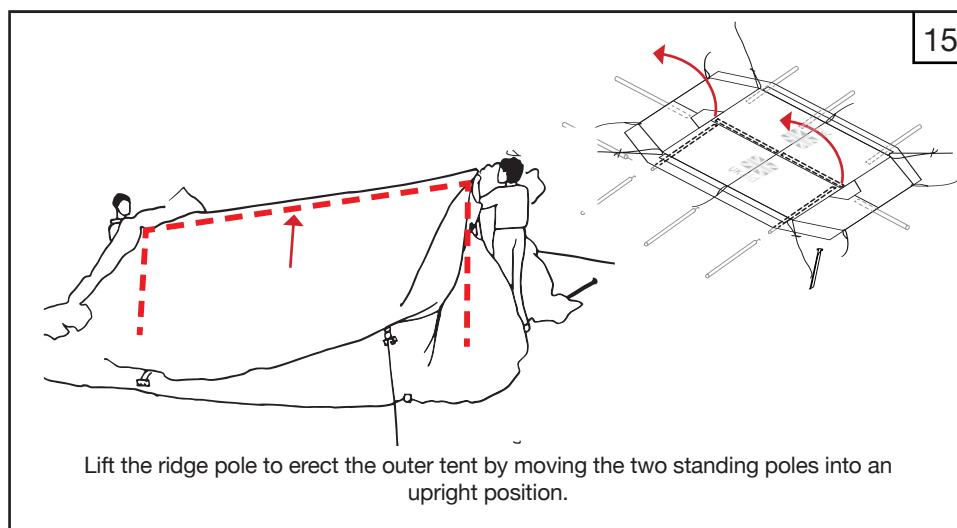
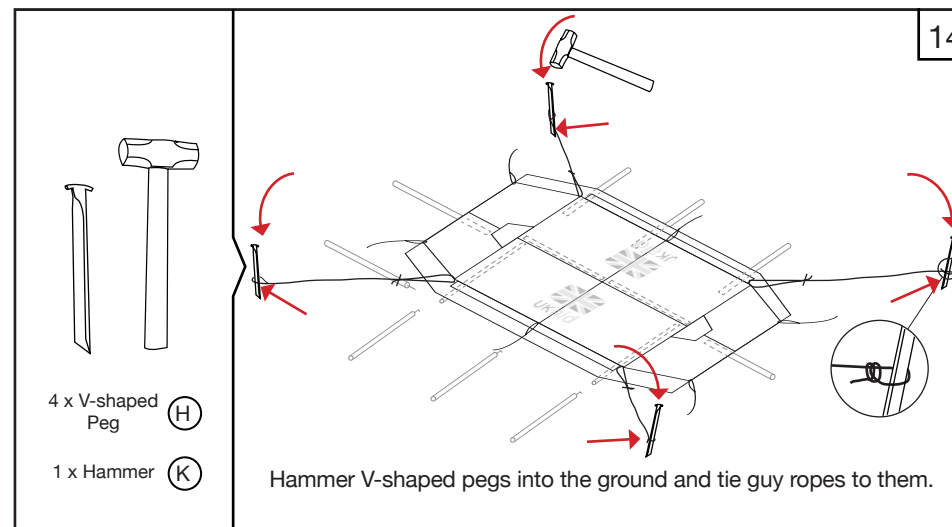
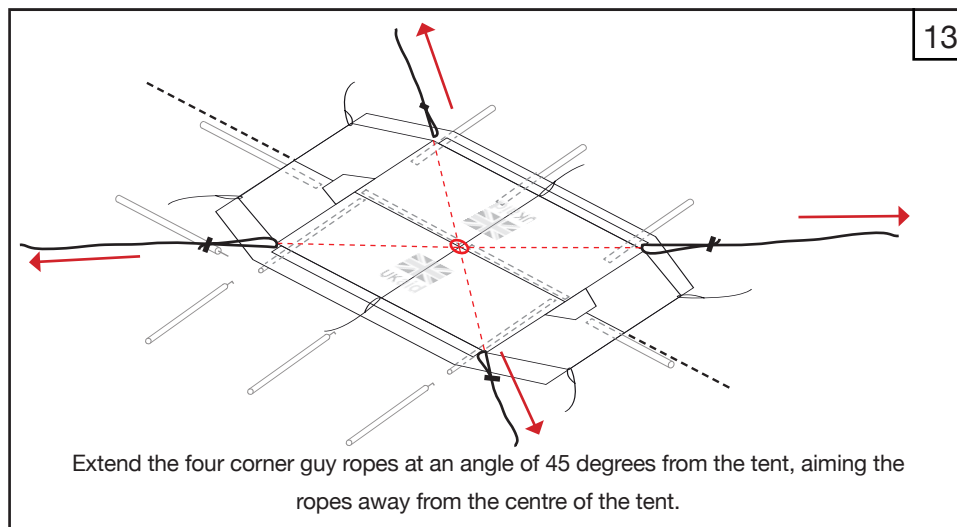

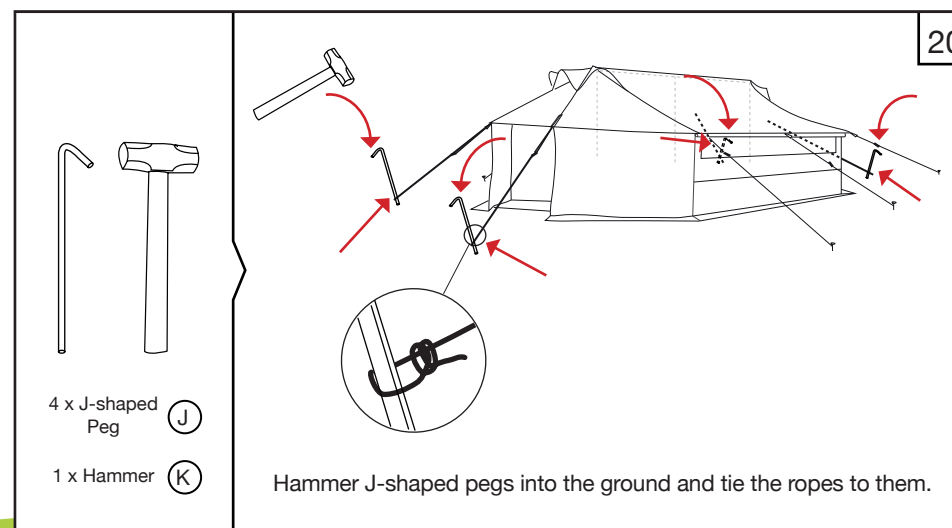
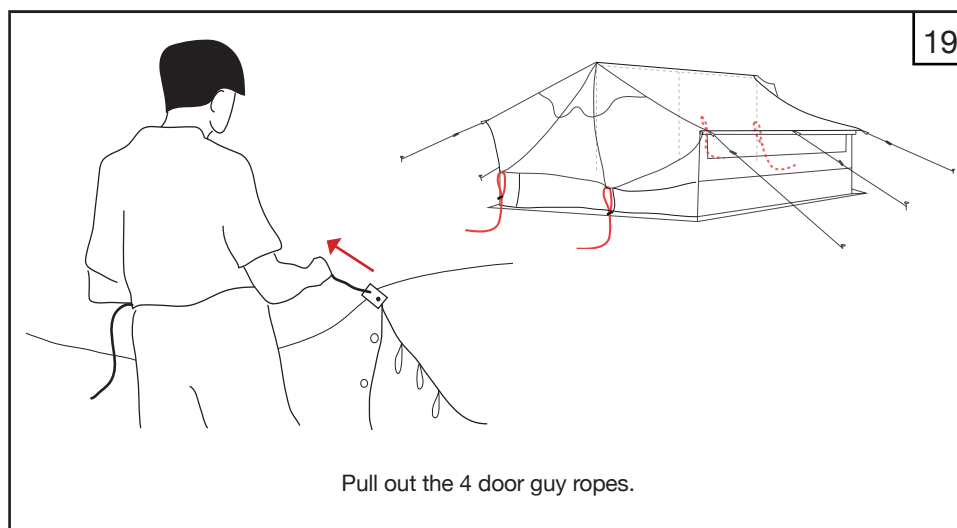
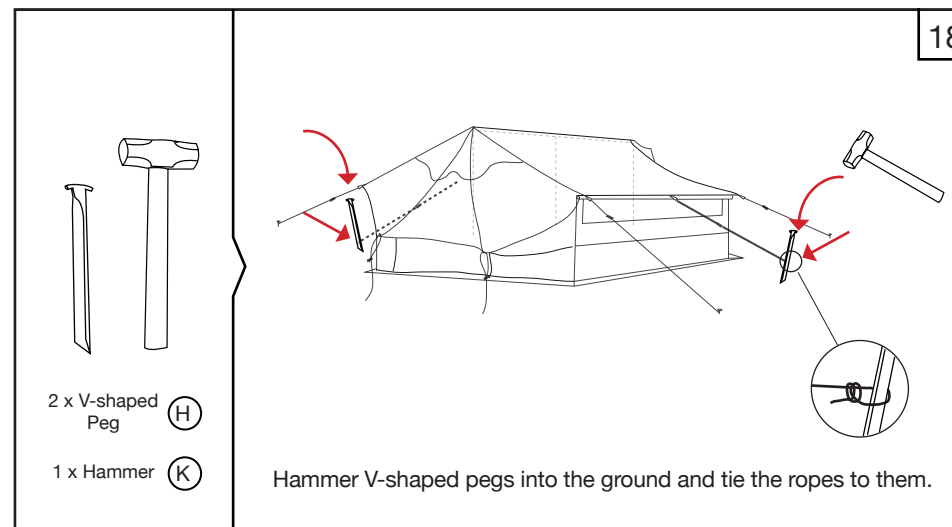
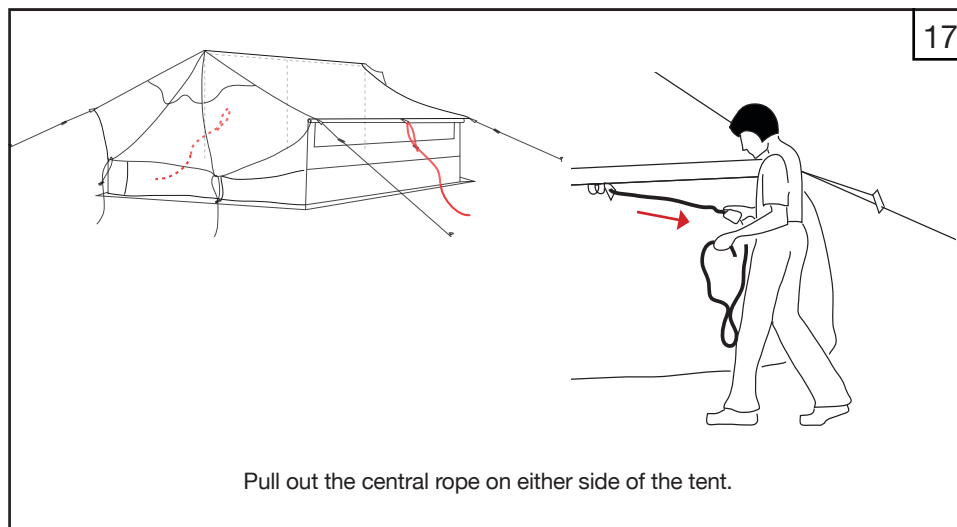



21

1.4 m

4 x door poles (G)

Erect the door poles. Ensure the top pins are inserted through the eyelets in the outer tent.

22

1.25 m

6 x side poles (F)

Erect the side poles from inside. Ensure the top hooks of the pole are inserted through the metal eyelets of the outer tent.

23

Roll up outer door flaps and secure with toggles at the top.

24

Tighten all guy ropes using the sliders.



25

Tie the outer tent to all 10 side and door poles using ribbons.

26

22 x steel pin (I)
1 x hammer (K)

Hammer steel pins through all eyelets of the outer tent mud flaps.

27

1 x inner tent (D)

Carry the inner tent inside. Unfold inner tent and attach onto the ridge pole using the hooks.

28

Tie each end of the inner tent to the standing poles using the ribbons.



29

Attach the inner tent to the outer tent ceiling using the toggles.

30

Clip the inner tent to the outer tent walls using the black plastic clips and D-rings.

31

4 x steel pin (I)
1 x hammer (K)

Hammer steel pins through the eyelets on either side of the doors.

32

2.2 m
1 x central standing pole (E)

Erect the central standing pole. The base of the pole rests on a reinforced square of ground sheet on the floor.



General Usage Notes:

- Window flaps can be opened and closed according to user requirements. To open, roll up and secure with the toggles.
- To open the front and back door flaps, roll up and secure with the toggles. To close door flaps, roll down and use the lacing system to secure each side.
- Internal ventilator window flaps and door flaps can be opened and closed according to user requirements. To open, roll and secure with the toggles.
- Roof ventilator flaps can be opened and closed by using the Velcro.
- Internal window flaps can be opened and closed by using the Velcro.